



OEM Bimetal Thermometer BBQ and Food Service

P-3A



BQB

BQ
Series

- All SS and heavy duty construction
- Crimped ring
- Hermetically sealed case
- Food, BBQ and cooking scale and reading
- Colorful scales available on request

HAWK BQ series thermometer is ideal to use for food service applications including food and beverage processing, barbecue, cooking and OEM equipments. The hermetically sealed case provides the weather and dust tight protection.

Our bimetal thermometers are welded all stainless steel construction and are hermetically sealed. These instruments are leak tested completely to insure the integrity of the joints in the process of producing. HAWK Supplies a wide selection of the available temperature ranges from -50°C to 550°C or equivalent in $^{\circ}\text{F}$.

Typical Application

- Barbecue pit testing
- Smoke testing
- Grill testing
- Beef well testing
- Meat and poultry testing
- Cooking
- Food and beverage processing
- Fry and Candy applications

Specification

Operating

The temperature of the case should not be allowed to be exposed to continuous temperature in excess of 200°F (95°C). If it is 150°F (65°C). Stem and bulb should not be contact with sustained process temperature exceeding 50% over-range or 800°F (425°C).

Immersion:

For getting the correct temperature readings, the stem of all models in all ranges must be immersed 2" deep in liquid, and 4" deep in gas except for $0/50^{\circ}\text{C}$ ($32/122^{\circ}\text{F}$) which require 3" deep in liquid, and 4" deep in gas.

Size:

2"(50mm), 2 1/2"(63mm) or 3"(80mm).

Case&Ring:

Stainless Steel 304(SS316-option), polished crimped ring.

Stem:

304 Stainless Steel, 1/4" diameter-Standard, 3/8" or others dia available.

Stem Length:

2 1/2", 4", 6", 9", 12", 15", 18", 24" standard lengths, available in stem lengths up to 72" long

Sensing Element:

Bimetallic Coil

Dial Face:

Aluminum, white background with black graduations and figure, anti-parallax to minimize the reading error available.

Window:

Plain Glass-standard

Pointer:

Anodized aluminum with black finish

Accuracy:

$\pm 1.0\%$ of span
(Grade A to ASME B40.3)

External Adjustment

External re-calibration on back.

Scale

$^{\circ}\text{C}$, $^{\circ}\text{F}$ (single or dual scale)

Connection Style

-Fixed Rigid Male/Female
-Sliding Compression Male/Female
-Union Rotatable Male/Nut Female
-Swivel nut Male/Female Rotatable
-Plain

Connection Size

1/2", 3/8", 1/4"NPT standard, JIS, DIN, M14*1.0, M20*1.5 and others available

Weatherproof

NEMA 4/4X or IP65 enclosure



OEM Bimetal Thermometer BBQ and Food Service

P-3A

Dimensions

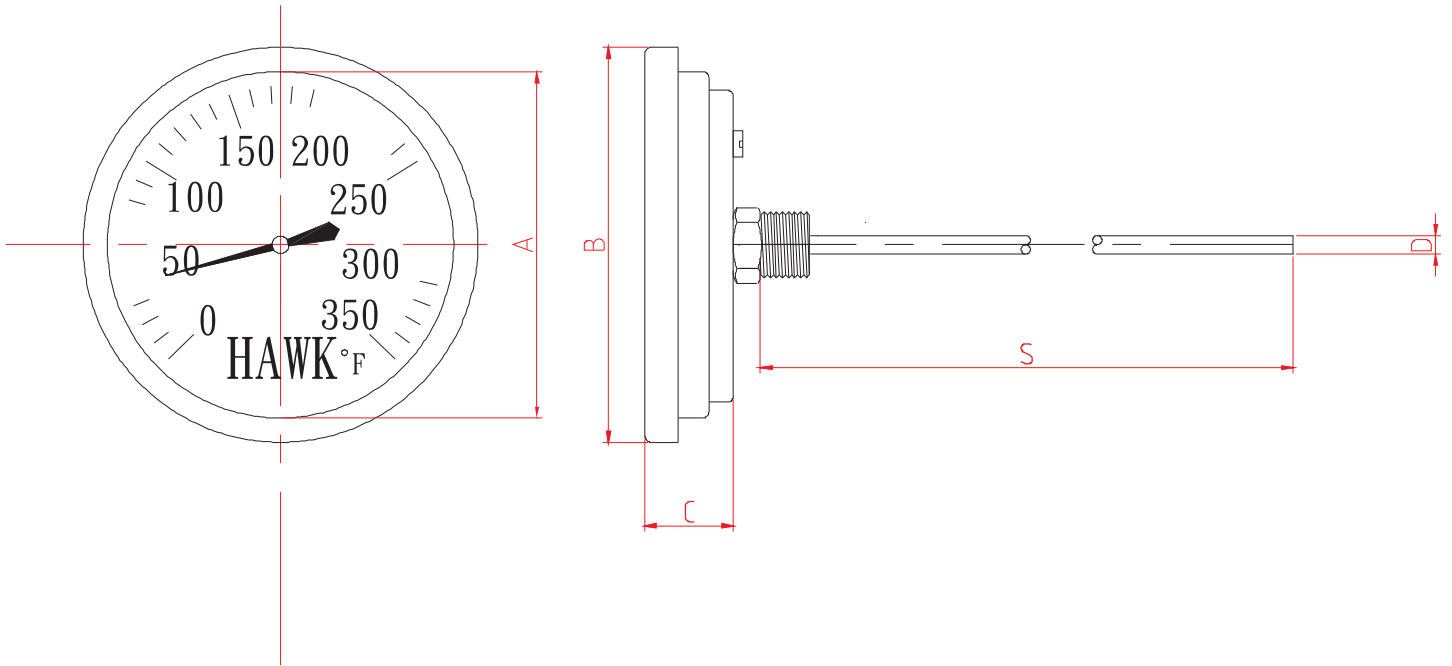

Size	A	B	C	D	S
2"(50mm)	1.93" (49mm)	2.28" (58mm)	0.59" (15mm)	1/4 to 3/8"	2 1/2"(63mm), 4"(100mm), 6"(150mm), 9"(225mm), 12"(300mm), 15"(380mm), 18"(450mm), 24"(600mm)
2 1/2"(63mm)	2.25" (57mm)	2.60" (66mm)	0.59" (15mm)	6mm, 6.35mm, 8mm, 10mm (option)	up to 72" are standard stem lengths. The other stem lengths are available on request.
3"(80mm)	2.76" (70mm)	3.31" (84mm)	0.71" (18mm)		

Popular Connection

Fixed/Rigid Type:

The fixed/rigid type is the most common connection. This threaded type connection is directly attached to the process by means of a male or female NPT, BSP, BSPT or other threads.

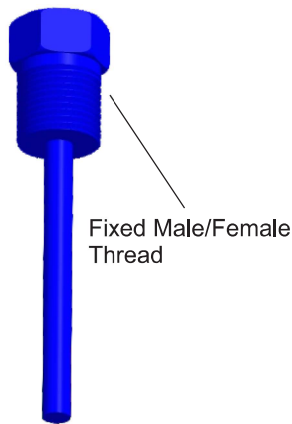

Union Type:

The Union type allows to tighten the rotating thread to fix the process connecting and turn the position of gauge face.

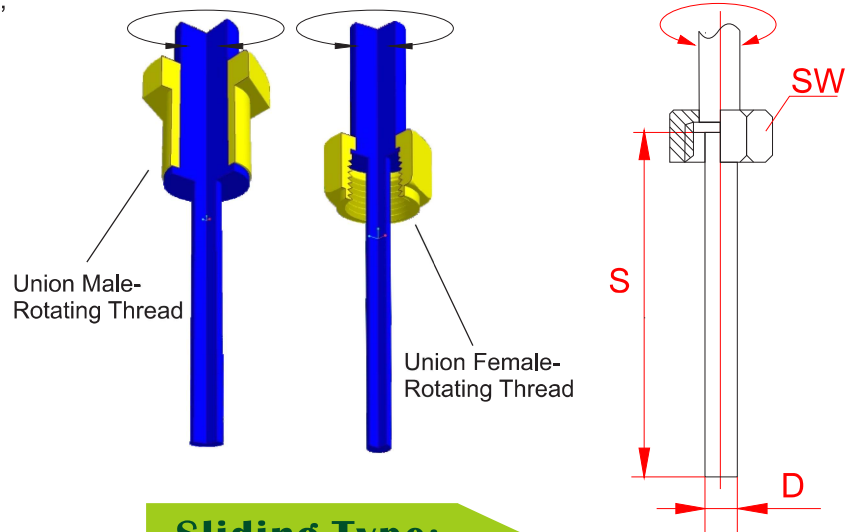

Swivel Nut:

The swivel connector is a double male adapter. It allows you to move around to turn the position of the gauge face.

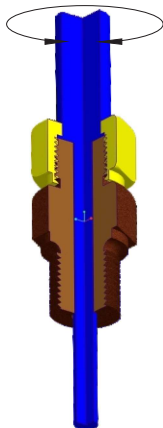

Sliding Type:

The sliding type allows to adjust the variable inserted length of bulb for best performance.

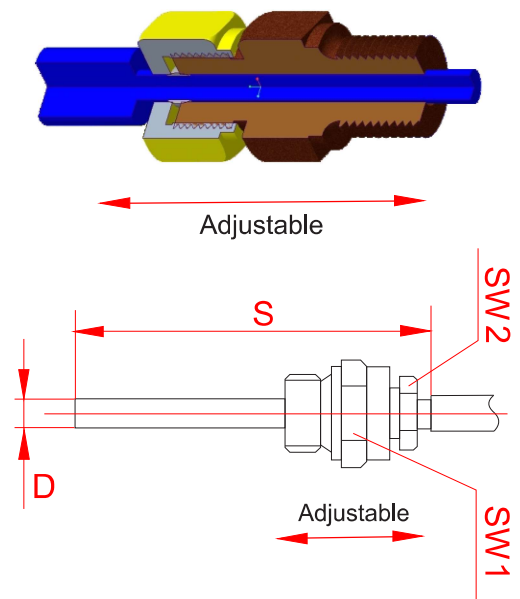

Plain Type:

The plain bulbs are suitable for open tank applications without any pressure or combine with thermowell for the applications where fixed installation is not required.





OEM Bimetal Thermometer BBQ and Food Service

Temperature Range

- The other scales and ranges(DIN) are available in request.
- Not all listed ranges and scales are in stock, consult your distributors for available.

Temperature Ranges					
SINGLE SCALE				DUAL SCALE	
°C		°F		°C / °F	
Code	Range	Code	Range	Code	Range
C3A	-30/30	F7A	-40/70	D3A	-30/30
C4A	-20/40	F10	0/100	D4A	-20/40
C5	0/50	F10A	-100/100	D5	0/50
C5A	-50/50	F12A	-20/120	D5A	-50/50
C6	0/60	F12C	-40/120	D6	0/60
C6B	-20/60	F12D	-80/120	D6B	-20/60
C7A	-40/70	F12G	25/125	D7A	-40/70
C7B	-70/70	F14	0/140	D7B	-70/70
C8	0/80	F15	0/150	D8	0/80
C10	0/100	F15A	-70/150	D10	0/100
C10A	-50/100	F16A	-40/160	D10A	-50/100
C11A	-10/110	F18B	-40/180	D11A	-10/110
C12	0/120	F20	0/200	D12	0/120
C12A	-20/120	F20B	-40/200	D12A	-20/120
C12C	-60/120	F20C	-100/200	D12C	-60/120
C15	0/150	F22	0/220	D15	0/150
C15B	50/150	F24A	20/240	D15B	50/150
C15C	10/150	F25	0/250	D15C	10/150
C16	0/160	F30	0/300	D16	0/160
C16A	-40/160	F30A	-50/300	D16A	-40/160
C20	0/200	F30C	50/300	D20	0/200
C20A	-50/200	F30D	200/300	D20A	-50/200
C22A	-20/220	F40A	50/400	D22A	-20/220
C22B	-80/220	F50	0/500	D22B	-80/220
C25	0/250	F50A	50/500	D25	0/250
C30	0/300	F55A	50/550	D30	0/300
C40	0/400	F60	0/600	D40	0/400
C40A	50/400	F75A	50/750	D40A	50/400
C45	0/450	F75C	150/750	D45	0/450
C50	0/500	F80A	100/800	D50	0/500
C50A	100/500	F100A	200/1000	D50A	100/500
C55A	100/550	F120	0/1200	D55A	100/550



OEM Bimetal Thermometer BBQ and Food Service

P-3A

Order Information

Example:

P-3A-BQ **B** **30** **M 2** **006** **150** **C10** **H-ZFZT**

Style	B Back																				
Dial	20 2"(50mm) 25 4"(100mm) 30 3"(80mm)																				
Connection Style	<table border="0"> <tr> <td>M Fixed Rigid Male</td> <td>F Fixed Rigid Female</td> <td>T Sliding Compression Male</td> <td>Y Sliding Compression Female</td> </tr> <tr> <td>U Union Turnable Male</td> <td>K Union Nut Female</td> <td colspan="2">X Swivel Nut Male Turnable (Double Male Adapter)</td> </tr> <tr> <td colspan="4">Z Swivel Nut Female Turnable (Male/female Adapter)</td> </tr> </table>	M Fixed Rigid Male	F Fixed Rigid Female	T Sliding Compression Male	Y Sliding Compression Female	U Union Turnable Male	K Union Nut Female	X Swivel Nut Male Turnable (Double Male Adapter)		Z Swivel Nut Female Turnable (Male/female Adapter)											
M Fixed Rigid Male	F Fixed Rigid Female	T Sliding Compression Male	Y Sliding Compression Female																		
U Union Turnable Male	K Union Nut Female	X Swivel Nut Male Turnable (Double Male Adapter)																			
Z Swivel Nut Female Turnable (Male/female Adapter)																					
Size	<table border="0"> <tr> <td>1 1"NPT</td> <td>5 3/4"NPT</td> <td>2 1/2"NPT</td> <td>3 3/8"NPT</td> <td>4 1/4"NPT</td> </tr> <tr> <td>U 1"PT(R)</td> <td>T 3/4"PT(R)</td> <td>A 1/2"PT(R)</td> <td>G 3/8"PT(R)</td> <td>B 1/4"PT(R)</td> </tr> <tr> <td>I 1"PF(G)</td> <td>Q 3/4"PF(G)</td> <td>D 1/2"PF(G)</td> <td>H 3/8"PF(G)</td> <td>E 1/4"PF(G)</td> </tr> <tr> <td>J M20*1.5</td> <td>K M14*1.0</td> <td colspan="3"></td> </tr> </table>	1 1"NPT	5 3/4"NPT	2 1/2"NPT	3 3/8"NPT	4 1/4"NPT	U 1"PT(R)	T 3/4"PT(R)	A 1/2"PT(R)	G 3/8"PT(R)	B 1/4"PT(R)	I 1"PF(G)	Q 3/4"PF(G)	D 1/2"PF(G)	H 3/8"PF(G)	E 1/4"PF(G)	J M20*1.5	K M14*1.0			
1 1"NPT	5 3/4"NPT	2 1/2"NPT	3 3/8"NPT	4 1/4"NPT																	
U 1"PT(R)	T 3/4"PT(R)	A 1/2"PT(R)	G 3/8"PT(R)	B 1/4"PT(R)																	
I 1"PF(G)	Q 3/4"PF(G)	D 1/2"PF(G)	H 3/8"PF(G)	E 1/4"PF(G)																	
J M20*1.5	K M14*1.0																				
Stem Diameter	C25 1/4" C32 5/16" C38 3/8" 006 6mm 008 8mm 010 10mm 012 12mm 																				
Stem Length	<table border="0"> <tr> <td>2C5 2.5"</td> <td>04C 4"</td> <td>06C 6"</td> <td>09C 9"</td> <td>12C 12"</td> <td>16C 16"</td> <td>24C 24"</td> </tr> <tr> <td>075 75mm</td> <td>100 100mm</td> <td>150 150mm</td> <td>200 200mm</td> <td>250 250mm</td> <td colspan="2">.....</td> </tr> </table>	2C5 2.5"	04C 4"	06C 6"	09C 9"	12C 12"	16C 16"	24C 24"	075 75mm	100 100mm	150 150mm	200 200mm	250 250mm							
2C5 2.5"	04C 4"	06C 6"	09C 9"	12C 12"	16C 16"	24C 24"															
075 75mm	100 100mm	150 150mm	200 200mm	250 250mm																
Temperature Range	<p>Please refer to the range table and write down the code you need.</p> <table border="0"> <tr> <td>Celsius</td> <td>Fahrenheit</td> </tr> </table>	Celsius	Fahrenheit																		
Celsius	Fahrenheit																				
Option	<table border="0"> <tr> <td>ZF Front Flange Case</td> <td>ZT Tempered Safety Glass</td> </tr> <tr> <td>ZG Glycerine Filled</td> <td>ZX Oxygen Cleaning</td> </tr> <tr> <td colspan="2">ZP PC Lens</td> </tr> </table> <p>Please refer to the options and write down the code which you need.</p>	ZF Front Flange Case	ZT Tempered Safety Glass	ZG Glycerine Filled	ZX Oxygen Cleaning	ZP PC Lens															
ZF Front Flange Case	ZT Tempered Safety Glass																				
ZG Glycerine Filled	ZX Oxygen Cleaning																				
ZP PC Lens																					

OP Plain
OL Other

B 30 M 2 006 150 C10 H-ZFZT

Process Connection



OEM Bimetal Thermometer BBQ and Food Service

P-3A

Option



- ZC** Certificate of Accuracy (Factory)
- ZE** Certificate of Accuracy (TAF)
- ZI** Certificate of Accuracy (NIST)
- Z1** Improved Accuracy 0.5%-mid Point (Grade 2A-ASME B40.3)

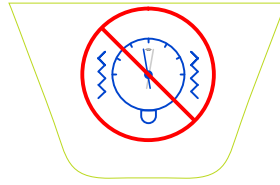

- ZG** Glycerine Filled
- ZS** Silicone Filled
- ZH** Halocarbon Filled
- ZO** Fluorolube Filled

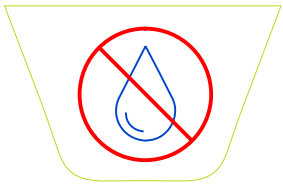

- ZX** Oxygen Cleaning



- ZN** NACE-MR0175-2002 Heat Treatment



- ZL** Laminated Safety Glass Lens
- ZP** Polycarbonate Lens
- ZT** Tempered Safety Glass Lens

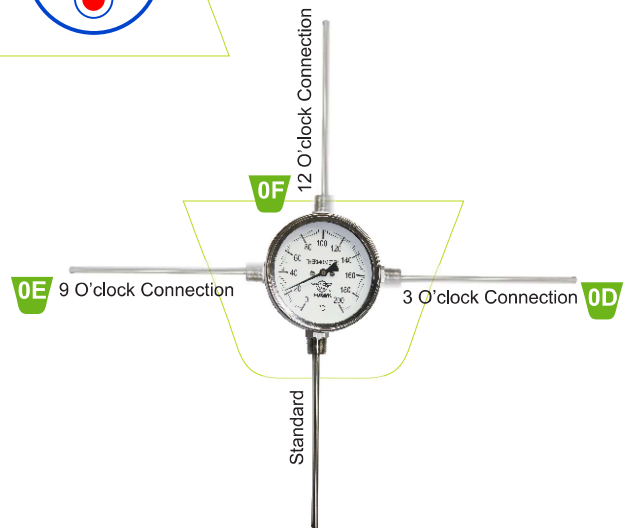

Option





OEM Bimetal Thermometer BBQ and Food Service

P-3A

Limited Warranty and Liability

HAWK GAUGE CO.,LTD warrants all its mechanical instruments to be free from defects in materials and workmanship. HAWK agrees to repair or replace any thermometers if returned to our factory, transportation charges prepaid, and after which examination reveals is to be defective due to faculty workmanship or material.

This warrant should not apply to subject to the following terms and conditions:

- A. The product has not been subjected to misuse, neglect, abuse , accident, incorrect mounting, improper use or misapplication such as negligence, accident, vandalism, shock or vibration.
- B. The performance of any system of which HAWK's products are a component part.
- C. The product has not been exposed to any other service, range or environment of greater severity than that for which the products were designed.
- D. The product has not been altered or repaired by anyone except HAWK GAUGE or its authorized service agencies.
- E. The serial number or date code has not been removed, defaced or changed.
- F. The actual pressure&temperature occurring exceed the values specified for HAWK Thermometer.

Unless otherwise specified in a manual or warranty card, or agree to in a writing signed by HAWK GAUGE office, HAWK Thermometer products shall be warranted for one years from the date of sale.

This warranty is in lieu of all other warranties expressed or implied, and of all obligations or liabilities on its part for damages including but not limited to consequential damages, following the use of misuse of instruments sold by it. No agent is authorized to assume for it any liability except as set forth above.

Note

HAWK GAUGE CO.,LTD reserves the right to make product improvements and change its specifications at any time stated throughout this brochure without notification. Please contact the factory on all critical dimensions and specifications for verification.

HAWK GAUGE is not expert in the customer's technical field and therefore doesn't warrant suitability of it's product for the application selected by customer.



Data Sheet No: MKDP3ABQA1-E