

HVAC/R Contractor Gauge

Stainless Steel Case

P-10

- ✔ Excellent Price and Performance Ratio
- ✔ 4 1/2" or 3 1/2" Dial Sizes
- ✔ 1% Accuracy
- ✔ Excellent Corrosion Resistance Stainless Steel Case
- ✔ Open Front/Removable Ring
- ✔ Zero Adjustable Screw on Dial



28L Series

- Typical Applications:
- ✍ Heating applications
 - ✍ Plumbing applications
 - ✍ Ventilating applications
 - ✍ Air conditioning applications
 - ✍ Refrigeration applications

HAWK **28L** contractor gauges are specifically designed to meet the specifications in HVAC/R (heating, ventilating, air conditioning, and refrigeration) industries. The gauges are intended to service the general pressure measurement of the construction industry on water, air, oil, gas or other mediums which do not attack the brass wetted parts. The gauge offers a high reliability at a economic price. A siphon should be installed to protect the pressure instruments from excessive temperature in live steam service or other hot vapor applications.

Specifications

Operating

Steady: 100%*full scale value
Pulsation: 90%*full scale value
Sudden: 130%*full scale value

The appropriate operating range falls in the middle half of the gauge (25% to 75% of full scale). If you choose the unsuitable range, the fatigue of bourdon tube may be resulted. HAWK Supplies a wide selection of range from vacuum to 1000 PSI including compound range.

Temperature limit

Ambient: -25 to 60°C (Dry Gauge)
Media: max 60°C-Standard
max 100°C-Option

Temperature effect

Accuracy of measurement will be effected by the temperature change. This inaccuracy may as high as $\pm 0.3\%$ for 12°C temperature change.

Dial Size

3 1/2" (90mm), 4 1/2"(115mm)

Case&Ring

Stainless Steel 304, polished push-in ring.

Socket

Brass.

Movement

Brass.

Bourdon Tube

Brass or phosphor bronze.

Window

Acrylic lens.

Pointer

Anodized aluminum with black finish.

Accuracy

$\pm 1.0\%$ of span
(Grade 1A to ASME B40.1)

Zero-Adjustment:

Micro-adjustable screw on dial.

Scale

PSI, kPa, Mpa, bar, kg/cm², inHg, cmHg, mmHg (single or dual scale)

Connection

1/4" NPT standard, BSP, BSPT, M14*1.0 available.

Mounting

Stem mounting.

Weatherproof

NEMA 3/IP54 enclosure.

Dimensions

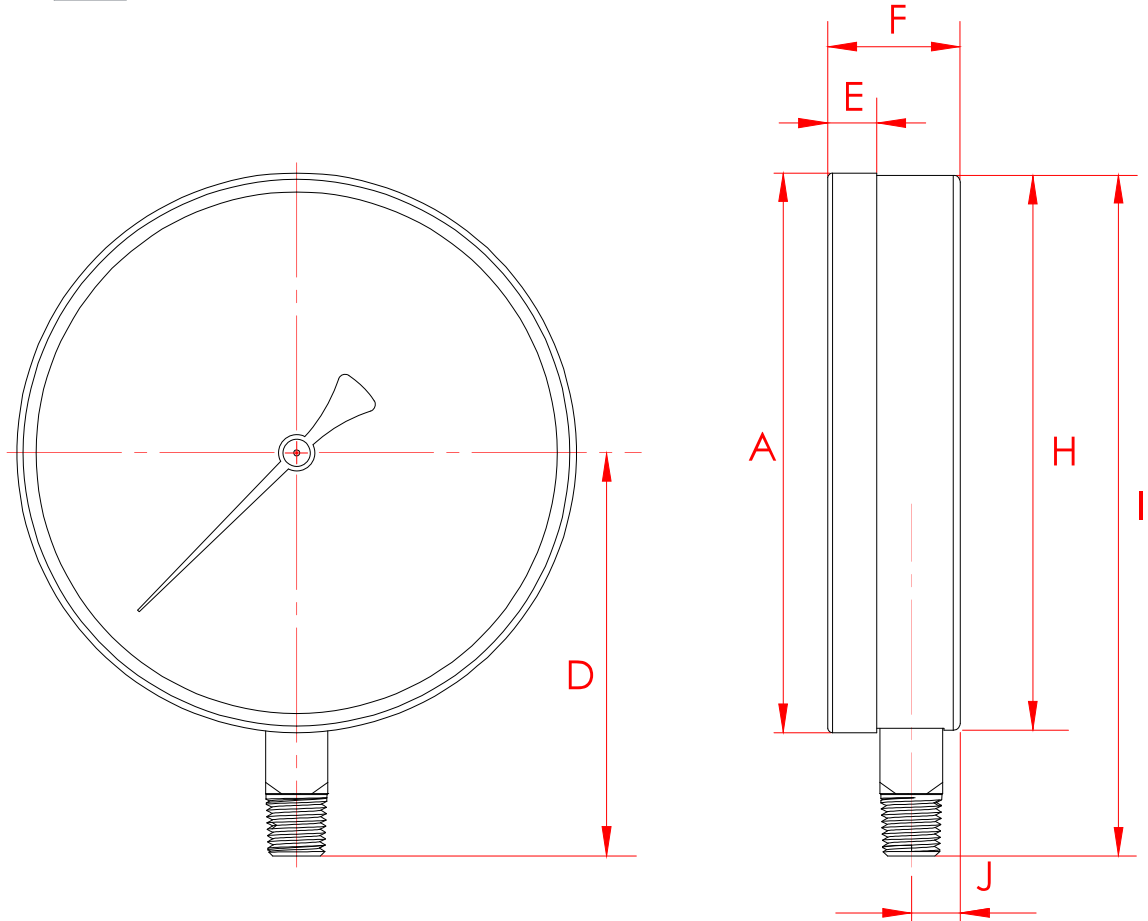

28L(Bottom Connection)

Dimensions, mm

Type No	Dial Size	A	B	C	D	E	F	G	H	I	J	K	Weight
28L	3.5"	95			70.1	12	30		93.7	117.6	10		0.28-0.35 Kg
28L	4.5"	125.6			90.5	11	31		124.2	153.8	10.9		0.35-0.42 Kg

HVAC/R Contractor Gauge

Stainless Steel Case

P-10

Pressure Ranges

1. The other scales and ranges(DIN) are available in request.
2. Not all listed ranges and scales are in stock, Consult your distributors for available.

Pressure Ranges

SINGLE SCALE		DUAL SCALE							
PSI		kg/cm ² & PSI		kPa & PSI		bar & PSI		kg/cm ² & kPa	
Code	Range	Code	Range	Code	Range	Code	Range	Code	Range
P32	15	W12	0/1kg/cm ² /psi	Y22	0/100kPa/psi	X12	0/1bar/psi	E12	0/1kg/cm ² /kPa
P35	30	W14	0/2kg/cm ² /psi	Y26	0/200kPa/psi	X14	0/2bar/psi	E14	0/2kg/cm ² /kPa
P39	60	W18	0/4kg/cm ² /psi	Y31	0/400kPa/psi	X18	0/4bar/psi	E18	0/4kg/cm ² /kPa
P41	100	W21	0/7kg/cm ² /psi	Y34	0/700kPa/psi	X21	0/7bar/psi	E21	0/7kg/cm ² /kPa
P43	160	W23	0/11kg/cm ² /psi	Y36A	0/1100kPa/psi	X23	0/11bar/psi	E23	0/11kg/cm ² /kPa
P44	200	W24	0/14kg/cm ² /psi	Y37	0/1400kPa/psi	X24	0/14bar/psi	E24	0/14kg/cm ² /kPa
P46	300	W28	0/21kg/cm ² /psi	Y40	0/2000kPa/psi	X28	0/20bar/psi	E28	0/20(21)kg/cm ² /kPa
P48	400	W30	0/28kg/cm ² /psi	Y42	0/2800kPa/psi	X30	0/28bar/psi	E30	0/28kg/cm ² /kPa
P50	600	W33	0/40kg/cm ² /psi	Y45	0/4000kPa/psi	X33	0/40bar/psi	E33	0/40kg/cm ² /kPa
P51	800	W35	0/60kg/cm ² /psi	Y47	0/6000kPa/psi	X35	0/60bar/psi	E35	0/60kg/cm ² /kPa
P52	1000	W36	0/70kg/cm ² /psi	Y48	0/7000kPa/psi	X36	0/70bar/psi	E36	0/70kg/cm ² /kPa

Vacuum Ranges

SINGLE SCALE		DUAL SCALE							
inHg		cmHg & inHg		kPa & inHg		bar & inHg		cmHg & kPa	
Code	Range	Code	Range	Code	Range	Code	Range	Code	Range
PV1	-30inHg/0	WV1	-76cmHg/inHg/0	YV1	-100kPa/inHg/0	XV1	-1bar/inHg/0	EV1	-76cmHg/kPa/0

Compound Ranges

DUAL SCALE

inHg & PSI		cmHg & kg/cm ²		kPa & PSI		bar & PSI	
Code	Range	Code	Range	Code	Range	Code	Range
PCA	-30inHg/0/15psi	GCB1	-76cmHg/1kg/cm ²	YCB	-100/+100 kPa/psi	XCB	-1/+1 bar/psi
PCB	-30inHg/0/30psi	GAC	-76cmHg/1.5kg/cm ²	YCD	-100/+200 kPa/psi	XCD	-1/+2 bar/psi
PCC	-30inHg/0/60psi	GAD	-76cmHg/2kg/cm ²	YCG	-100/+400 kPa/psi	XCG	-1/+4 bar/psi
PCD	-30inHg/0/100psi	GAG	-76cmHg/4kg/cm ²	YCJ	-100/+700 kPa/psi	XCJ	-1/+7 bar/psi
PCE	-30inHg/0/150psi	GAJ	-76cmHg/7kg/cm ²	YCL	-100/+1000 kPa/psi	XCL	-1/+10 bar/psi
PCF	-30inHg/0/160psi	GAL	-76cmHg/10kg/cm ²	YCO	-100/+1400 kPa/psi	XCO	-1/+14 bar/psi
PCG	-30inHg/0/200psi	GAO	-76cmHg/14kg/cm ²	YCS	-100/+2100 kPa/psi	XCS	-1/+21 bar/psi
PCH	-30inHg/0/300psi	GAS	-76cmHg/21kg/cm ²				

Order Information

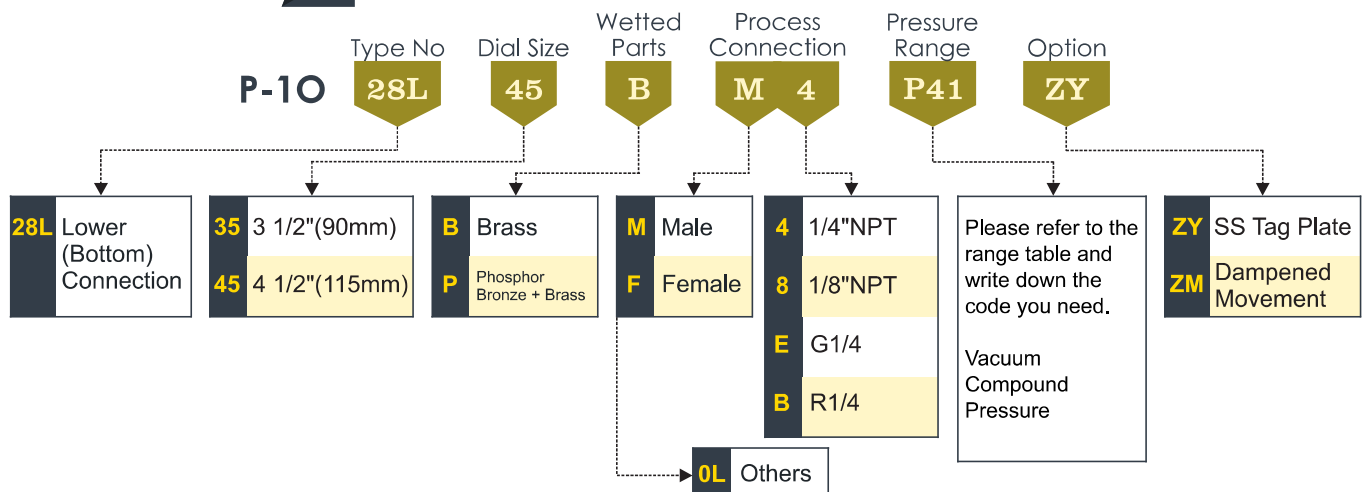

HVAC/R Contractor Gauge

Stainless Steel Case

P-10

Option

Certificate of Accuracy (NIST)

ZI



ZC

Certificate of Accuracy (Factory)

ZE

Certificate of Accuracy (TAF)

Dampened Movement

ZM

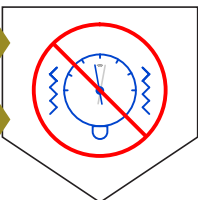

Double Restrictor Screw

ZR

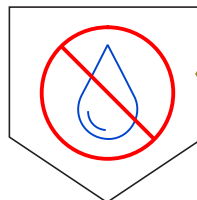

ZX

Cleaned for Oxygen Service (Use No Oil)

Improved Temperature Resistance

PB

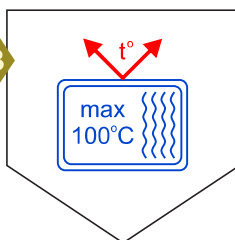

ZY

Stainless Steel Tag Plate

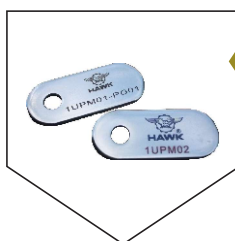

9 O'clock Connection

0E

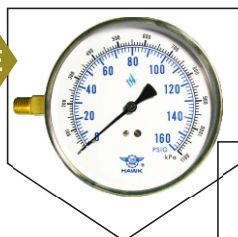

0D

3 O'clock Connection

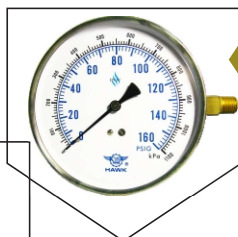

0F

12 O'clock Connection

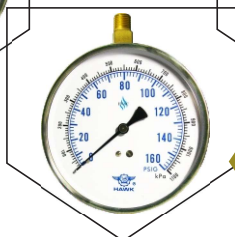



HVAC/R Contractor Gauge Stainless Steel Case

P-10

Limited Warranty and Liability

HAWK GAUGE CO.,LTD warrants all its mechanical instruments to be free from defects in materials and workmanship. HAWK agrees to repair or replace any pressure gauges if returned to our factory, transportation charges prepaid, and after which examination reveals is to be defective due to faculty workmanship or material.

This warrant should not apply to subject to the following terms and conditions:

- A. The product has not been subjected to misuse, neglect, abuse , accident, incorrect mounting, improper use or misapplication such as negligence, accident, vandalism, shock or vibration.
- B. The performance of any system of which HAWK's products are a component part.
- C. The product has not been exposed to any other service, range or environment of greater severity than that for which the products were designed.
- D. The product has not been altered or repaired by anyone except HAWK GAUGE or its authorized service agencies.
- E. The serial number or date code has not been removed, defaced or changed.
- F. The actual pressure&temperature occurring exceed the values specified for HAWK Process gauge.

Unless otherwise specified in a manual or warranty card, or agree to in a writing signed by HAWK GAUGE office, HAWK Process gauge products shall be warranted for one years from the date of sale.

This warranty is in lieu of all other warranties expressed or implied, and of all obligations or liabilities on its part for damages including but not limited to consequential damages, following the use of misuse of instruments sold by it.

No agent is authorized to assume for it any liability except as set forth above.

Note

HAWK GAUGE CO.,LTD reserves the right to make product improvements and change its specifications at any time stated throughout this brochure without notification. Please contact the factory on all critical dimensions and specifications for verification.

HAWK GAUGE is not expert in the customer's technical field and therefore doesn't warrant suitability of it's product for the application selected by customer.



Data Sheet No: MKDP1O28A1-E