



HAWK

Since 1971

Large Size Pressure Gauge Aluminum Case

www.hawkgauge.com.tw

P-1J

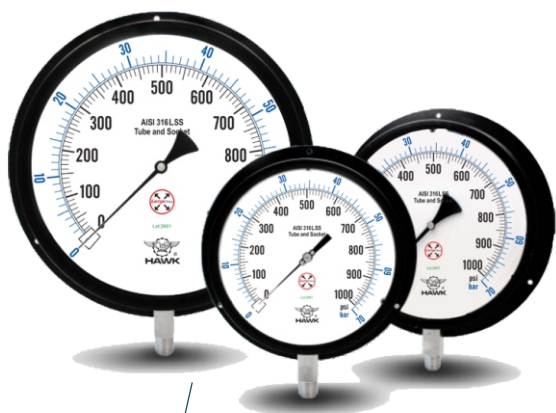

**10L, 10B
Series**

- 8", 10", 12" Large Size for Easy Readability
- Back Flange Surface Mounting
- Heavy Duty Bourdon Tube/ Rotary Geared Movement
- Open Front/Removable Ring
- Shock and Vibration Resistance

HAWK type 10L and 10B large size process gauges are supplied with an aluminum back flange case with a black wrinkle enamel finish. The dial sizes are available in 8"(200mm), 10"(250mm) and 12"(300mm). These gauge are suitable where the distance is a factor and the gauge needs expanded dial graduations for easy readability. This gauge is available in bottom connection (10L) or lower back connection (10B) for surface mounting.

Typical Application

- Petrochemical and chemical processing
- Offshore oil Platforms
- Industrial OEM equipment
- Power generating stations
- Pneumatic systems
- Construction and agriculture equipment
- Energy and water treatment plants

Specification

Operating

Steady: 100%*full scale value
Pulsation: 90%*full scale value
Sudden: 130%*full scale value

The appropriate operating range falls in the middle half of the gauge (25% to 75% of full scale). If you choose the unsuitable range, the fatigue of bourdon tube may be resulted. HAWK Supplies a wide selection of range from vacuum to 20000 PSI including compound range.

Temperature limit

Ambient: -40 to 80°C (Dry Gauge).
Media: max 60°C-Brass.

125°C-SS (Standard).

300°C (Option) with cooling equipment.

Temperature effect

Accuracy of measurement will be effected by the temperature change. This inaccuracy may as high as $\pm 0.3\%$ for 12°C temperature change.

Dial Size

8"(200mm), 10"(250mm), 12"(300mm).

Case&Ring

Aluminum case and ring with wrinkle black enamel.

Socket

Brass, 316L Stainless Steel or Monel K400.

Movement

Stainless steel movement with overload and underload stops - Standard, Dampened movement on request.

Bourdon Tube

Brass, 316L Stainless Steel or Monel K500 30"Hg(Vac) to 1500PSI...C-type 2000 to 20000PSI...Helical type.

Window

Plain glass or Tempered safety glass - Standard, Polycarbonate window - Option.

Pointer

Anodized aluminum with black finish.

Accuracy

$\pm 1.0\%$ of span (Grade 1A to ASME B40.1)

Scale

PSI, kPa, Mpa, bar, kg/cm², inHg, cmHg, torr, mmHg (single or dual scale).

Connection

1/2", 3/8", 1/4" NPT standard, JIS, DIN and M20*1.5 available.

Mounting

Surface mounting.

Weatherproof

NEMA 3/3X (P54) enclosure.

Dimensions

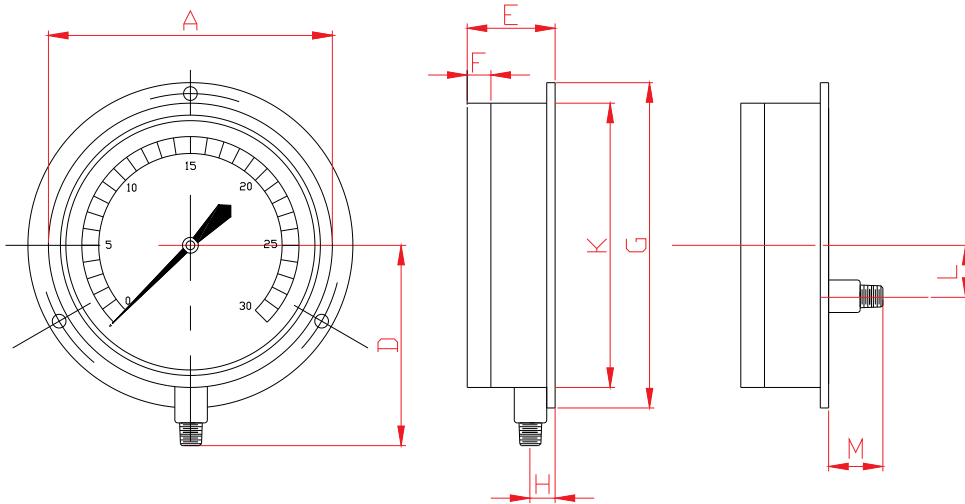

Dimensions, in.(mm)

Type No	Dial Size	A	B	C	D	E	F	G	H	M	K	L	Weight
10L/B	8" (200)	7.88" (200)	8.66" (220)	0.22" (5.5)	6.22" (158)	1.40" (35.5)	0.63" (16)	9.13" (232)	0.59" (15)	1.34" (34)	7.88" (200)	1.34 (34)	2.1-2.5 Kg
	10" (250)	9.83" (250)	10.55" (268)	0.22" (5.5)	7.21" (183)	1.40" (35.5)	0.63" (16)	11.26" (286)	0.59" (15)	1.34" (34)	9.83" (250)	1.34 (34)	2.7-3.1 Kg
	12" (300)	11.81" (300)	12.72" (328)	0.22" (5.5)	8.19" (208)	1.40" (35.5)	0.63" (16)	13.39" (340)	0.59" (15)	1.34" (34)	11.81" (300)	1.34 (34)	3.2-3.6 Kg

Accessories

Please refer to HAWK diaphragm seal and accessories data sheets for detailed information.

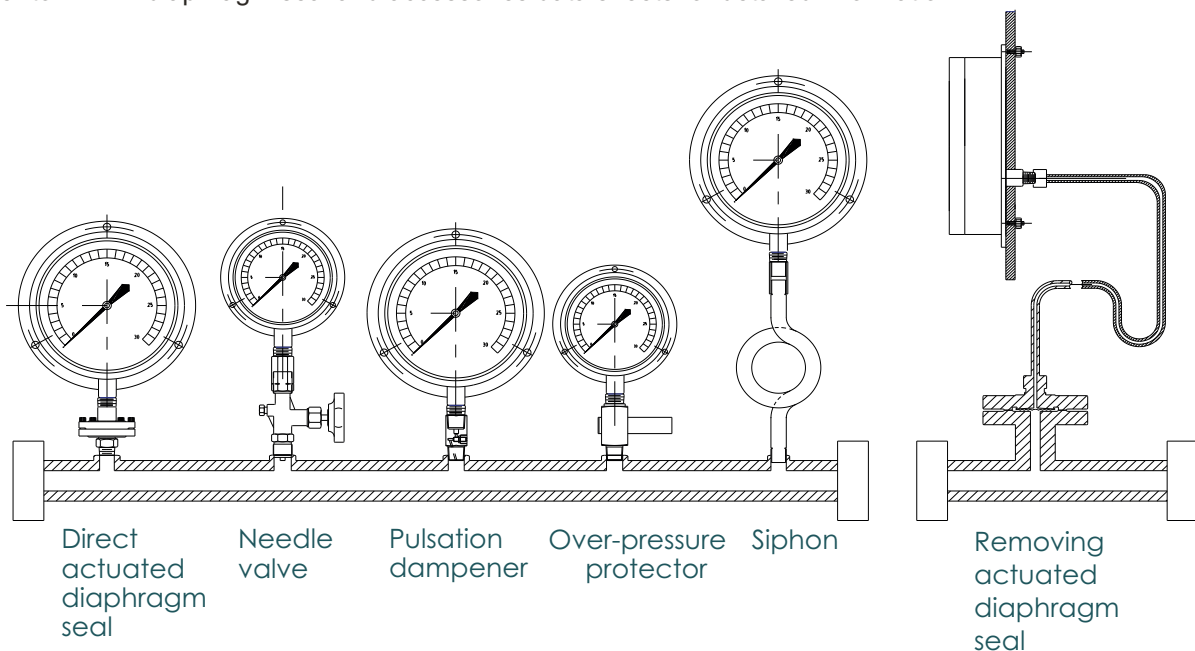

Temperature Range

- The other scales and ranges(DIN) are available in request.
- Not all listed ranges and scales are in stock, consult your distributors for the detailed information.

Pressure Ranges

SINGLE SCALE				DUAL SCALE									
PSI		Bar		KPa		Kg/cm ²		Bar & PSI		Kpa & PSI		Kg/cm ² & PSI	
Code	Range	Code	Range	Code	Range	Code	Range	Code	Range	Code	Range	Code	Range
P29	6	R1	0.4	K29	40	G1	0.4	X9	0.4 Bar/PSI	Y16	40 kPa/PSI	W9	0.4 Kg/cm ² /PSI
P30	8	R2	0.6	K31	60	G2	0.6	X11	0.6 Bar/PSI	Y18	60 kPa/PSI	W11	0.6 Kg/cm ² /PSI
P32	15	R3	1	K33	100	G3	1	X12	1 Bar/PSI	Y22	100 kPa/PSI	W12	1 Kg/cm ² /PSI
P33	20	R4	1.6	K34	160	G4	1.6	X13	1.6 Bar/PSI	Y25	160 kPa/PSI	W13	1.6 Kg/cm ² /PSI
P35	30	R5	2	K35	200	G5	2	X14	2 Bar/PSI	Y26	200 kPa/PSI	W14	2 Kg/cm ² /PSI
P37	40	R6	2.5	K36	250	G6	2.5	X15	2.5 Bar/PSI	Y27	250 kPa/PSI	W15	2.5 Kg/cm ² /PSI
P38	50	R7	3	K37	300	G7	3	X16	3 Bar/PSI	Y28	280 kPa/PSI	W16	3 Kg/cm ² /PSI
P39	60	R8	4	K38	400	G9	4	X18	4 Bar/PSI	Y31	400 kPa/PSI	W18	4 Kg/cm ² /PSI
P40	80	R9	5	K39	500	G10	5	X19	5 Bar/PSI	Y32	500 kPa/PSI	W19	5 Kg/cm ² /PSI
P40A	85	R11	6	K40	600	G11	6	X20	6 Bar/PSI	Y33	600 kPa/PSI	W20	6 Kg/cm ² /PSI
P41	100	R12	7	K41	700	G12	7	X21	7 Bar/PSI	Y34	700 kPa/PSI	W21	7 Kg/cm ² /PSI
P42	150	R13	10	K42	1000	G13	10	X22	10 Bar/PSI	Y36	1000 kPa/PSI	W22	10 Kg/cm ² /PSI
P43	160	R13A	11	K42A	1100	G13A	11	X23	11 Bar/PSI	Y36A	1100 kPa/PSI	W23	11 Kg/cm ² /PSI
P43A	180	R13B	14	K42B	1400	G13C	14	X24	14 Bar/PSI	Y37	1400 kPa/PSI	W24	14 Kg/cm ² /PSI
P44	200	R13C	15	K42C	1500	G13B	15	X25	15 Bar/PSI	Y38	1500 kPa/PSI	W25	15 Kg/cm ² /PSI
P45	250	R14	16	K43	1600	G14	16	X26	16 Bar/PSI	Y39	1600 kPa/PSI	W26	16 Kg/cm ² /PSI
P46	300	R15	20	K44	2000	G15	20	X28	20 Bar/PSI	Y40	2000 kPa/PSI	W28	20 Kg/cm ² /PSI
P47	350	R16	25	K45	2500	G16	25	X29	25 Bar/PSI	Y41	2500 kPa/PSI	W29	25 Kg/cm ² /PSI
P48	400	R16B	28	K55A	2800	G16A	28	X30	28 Bar/PSI	Y42	2800 kPa/PSI	W30	28 Kg/cm ² /PSI
P48A	450	R17	30	K46	3000	G17	30	X31	30 Bar/PSI	Y43	3000 kPa/PSI	W31	30 Kg/cm ² /PSI
P49	500	R18	35	K47	3500	G18	35	X32	35 Bar/PSI	Y44	3500 kPa/PSI	W32	35 Kg/cm ² /PSI
P50	600	R19	40	K48	4000	G19	40	X33	40 Bar/PSI	Y45	4000 kPa/PSI	W33	40 Kg/cm ² /PSI
P51	800	R20	50	K49	5000	G20	50	X34	50 Bar/PSI	Y46	5000 kPa/PSI	W34	50 Kg/cm ² /PSI
P51A	850	R21	60	K50	6000	G21	60	X35	60 Bar/PSI	Y47	6000 kPa/PSI	W35	60 Kg/cm ² /PSI
P52	1,000	R22	70	K51	7000	G22	70	X36	70 Bar/PSI	Y48	7000 kPa/PSI	W36	70 Kg/cm ² /PSI
P53	1,500	R23	100	K52	10000	G23	100	X39	100 Bar/PSI	Y50	10000 kPa/PSI	W39	100 Kg/cm ² /PSI
P53A	1,600	R23A	140	K52B	14000	G23A	140	X40	140 Bar/PSI	Y51	14000 kPa/PSI	W40	140 Kg/cm ² /PSI
P54	2,000	R24	160	K53	16000	G24	160	X42	160 Bar/PSI	Y53	16000 kPa/PSI	W42	160 Kg/cm ² /PSI
P56	3,000	R25	200	K54	20000	G25	200	X43	200 Bar/PSI	Y54	20000 kPa/PSI	W43	200 Kg/cm ² /PSI
P57	3,500	R26	250	K55	25000	G26	250	X44	250 Bar/PSI	Y55	25000 kPa/PSI	W44	250 Kg/cm ² /PSI
P58	4,000	R26A	280	K55A	28000	G26A	280	X44A	280 Bar/PSI	Y56	28000 kPa/PSI	W44A	280 Kg/cm ² /PSI
P58A	4,250	R27	300	K56	30000	G27	300	X45	300 Bar/PSI	Y57	30000 kPa/PSI	W45	300 Kg/cm ² /PSI
P59	5,000	R28	350	K56A	35000	G28	350	X46	350 Bar/PSI	Y58	35000 kPa/PSI	W46	350 Kg/cm ² /PSI
P60	6,000	R29	400	K57	40000	G29	400	X47	400 Bar/PSI	Y59	40000 kPa/PSI	W47	400 Kg/cm ² /PSI
P60B	7,000	R30	500	K58	50000	G30	500	X48	500 Bar/PSI	Y60	50000 kPa/PSI	W48	500 Kg/cm ² /PSI
P61	8,000	R31	600	K59	60000	G31	600	X49	600 Bar/PSI	Y61	60000 kPa/PSI	W49	600 Kg/cm ² /PSI
P62	10,000	R33	700	K60	70000	G32	700	X50	700 Bar/PSI	Y62	70000 kPa/PSI	W50	700 Kg/cm ² /PSI
P63	15,000	R33	1000	K61	100000	G33	1000	X52	1000 Bar/PSI	Y64	100000 kPa/PSI	W52	1000 Kg/cm ² /PSI
P64	20,000	R33A	1400	K61A	140000	G33A	1400	X53	1400 Bar/PSI	Y65	140000 kPa/PSI	W53	1400 Kg/cm ² /PSI
P65	25,000	R34	1600	K62	160000	G34A	1600	X55	1600 Bar/PSI	Y67	160000 kPa/PSI	W55	1600 Kg/cm ² /PSI

Vacuum Ranges

SINGLE SCALE				DUAL SCALE		
InHg	Bar	KPa	Kg/cm2	Bar & PSI	Kpa & PSI	Kg/cm2 & PSI
Code Range	Code Range	Code Range	Code Range	Code Range	Code Range	Code Range
PV1 -30/0	RV1 -1/0	KV1 -0.04	GV1 -1/0	XV1 -1 Bar/PSI	YV1 -100 kPa/PSI	WV1 -76 cmHg/inHg

Compound Ranges

SINGLE SCALE				DUAL SCALE		
PSI	Bar	KPa	Kg/cm2	Bar & PSI	Kpa & PSI	Kg/cm2 & PSI
Code Range	Code Range	Code Range	Code Range	Code Range	Code Range	Code Range
PCA1 VAC/8.5	RCA -1/0.6	KOQ -100/60	GCA -1/0.6	XCA -1/0.6 Bar/PSI	YCA -100/60 kPa/PSI	WCA -76cmHg/0.6 Kg/cm2
PCA VAC/15	RCB -1/1	KOR -100/100	GCB -1/1	XCB -1/1 Bar/PSI	YCB -100/100 kPa/PSI	WCB -76cmHg/1 Kg/cm2
PCB VAC/30	RCC -1/1.5	KOS -100/150	GCC -1/1.5	XCC -1/1.5 Bar/PSI	YCC -100/150 kPa/PSI	WCC -76cmHg/1.5 Kg/cm2
	RCD -1/2	KOS1 -100/200	GCD -1/2	XCD -1/2 Bar/PSI	YCD -100/200 kPa/PSI	WCD -76cmHg/2 Kg/cm2
PCC VAC/60	RCE -1/2.5	KOS2 -100/250	GCE -1/2.5	XCE -1/2.5 Bar/PSI	YCE -100/250 kPa/PSI	WCE -76cmHg/2.5 Kg/cm2
	RCF -1/3	KOT -100/300	GCF -1/3	XCF -1/3 Bar/PSI	YCF -100/300 kPa/PSI	WCF -76cmHg/3 Kg/cm2
PCD VAC/100	RCG -1/4	KOT2 -100/400	GCG -1/4	XCG -1/4 Bar/PSI	YCG -100/400 kPa/PSI	WCG -76cmHg/4 Kg/cm2
	RCH -1/5	KOU -100/500	GCH -1/5	XCH -1/5 Bar/PSI	YCH -100/500 kPa/PSI	WCH -76cmHg/5 Kg/cm2
PCE VAC/150	RCJ -1/7	KOU2 -100/700	GCJ -1/7	XCJ -1/7 Bar/PSI	YCJ -100/700 kPa/PSI	WCJ -76cmHg/7 Kg/cm2
	RCK -1/9	KOV -100/900	GCK -1/9	XCK -1/9 Bar/PSI	YCK -100/900 kPa/PSI	WCK -76cmHg/9 Kg/cm2
PCF VAC/160	RCL -1/10	KOV1 -100/1000	GCL -1/10	XCL -1/10 Bar/PSI	YCL -100/1000 kPa/PSI	WCL -76cmHg/10 Kg/cm2
PCG VAC/200	RCM -1/11	KOV2 -100/1100	GCM -1/11	XCM -1/11 Bar/PSI	YCM -100/1100 kPa/PSI	WCM -76cmHg/11 Kg/cm2
	RCO -1/14	KOV4 -100/1400	GCO -1/14	XCO -1/14 Bar/PSI	YCO -100/1400 kPa/PSI	WCO -76cmHg/14 Kg/cm2
PCH VAC/300	RCP -1/15	KOW -100/1500	GCP -1/15	XCP -1/15 Bar/PSI	YCP -100/1500 kPa/PSI	WCP -76cmHg/15 Kg/cm2
	RCR -1/19	KOW2 -100/1900	GCR -1/19	XCR -1/19 Bar/PSI	YCR -100/1900 kPa/PSI	WCR -76cmHg/19 Kg/cm2
PCI VAC/400	RCS -1/20	KOW3 -100/2000	GCS -1/20	XCS -1/20 Bar/PSI	YCS -100/2000 kPa/PSI	WCS -76cmHg/20 Kg/cm2
	RCT -1/24	KOX -100/2400	GCT -1/24	XCT -1/24 Bar/PSI	YCT -100/2400 kPa/PSI	WCT -76cmHg/24 Kg/cm2
PCJ VAC/500	RCU -1/25	KOX1 -100/2500	GCU -1/25	XCU -1/25 Bar/PSI	YCU -100/2500 kPa/PSI	WCU -76cmHg/25 Kg/cm2
	RCV -1/27	KOX2 -100/2700	GCV -1/27	XCV -1/27 Bar/PSI	YCV -100/2700 kPa/PSI	WCV -76cmHg/27 Kg/cm2
PCK VAC/600	RCW -1/30	KOY -100/3000	GCW -1/30	XCW -1/30 Bar/PSI	YCW -100/3000 kPa/PSI	WCW -76cmHg/30 Kg/cm2
	RCX -1/40	KOZ -100/3500	GCW1 -1/35	XCX -1/35 Bar/PSI	YCX -100/3500 kPa/PSI	WCX -76cmHg/35 Kg/cm2
	RCY -1/50	KOZ1 -100/4000	GCX -1/40	XCX1 -1/40 Bar/PSI	YCY -100/4000 kPa/PSI	WCY -76cmHg/40 Kg/cm2
	RCZ -1/60	KOZ2 -100/5000	GCY -1/50	XCZ -1/50 Bar/PSI	YCY -100/5000 kPa/PSI	WCZ -76cmHg/50 Kg/cm2
	RC0 -1/100	KOZ3 -100/6000	GCZ -1/60	XC1 -1/60 Bar/PSI	YCY -100/6000 kPa/PSI	WC1 -76cmHg/60 Kg/cm2
		KOZ7 -100/10000	GC0 -1/100	XC2 -1/100 Bar/PSI	YCY -100/10000 kPa/PSI	WC2 -76cmHg/100 Kg/cm2

Order Information

Example:

Series
P - 1J - 10

Model
L

Dial
08

Wetted Parts
W

Process Connection
M 2

Pressure Range
P 4 1

Option
H-Z C

L- Lower (Bottom) Connection
B- Lower Back Connection

08-8" (200mm)
10-10" (250mm)
12-12" (300mm)

W-316LSS
M-Monel
B-Brass

M-Male 2-1/2"NPT
F-Female 4-1/4"NPT
D-1/2"PF
0L-Others
20-20mm Socket Wetted

Please refer to the range table and write down the code you need.

Vacuum
Compound
Pressure

ZC-Certificate of Accuracy Factory
ZM-Dampened Movement
ZX-Cleaned for Oxygen Service
Z7-Retard Scale
ZT-Tempered Safety Glass Lens
Z1-Improved Accuracy 1 Degree
ZE-Certificate of Accuracy(TAF)
ZY-Stainless Steel Tag Plate

Other options please check the next page

Option

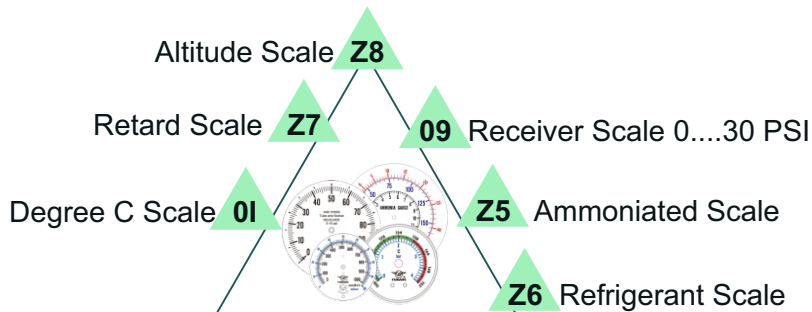
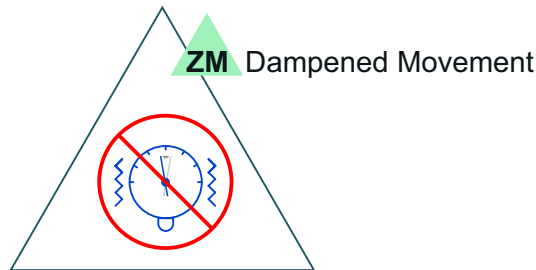
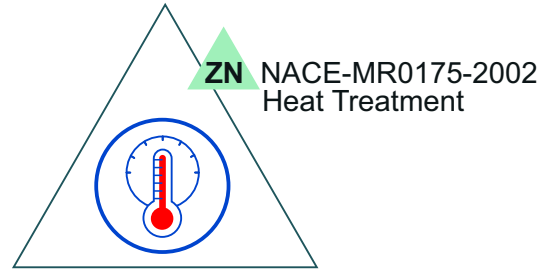
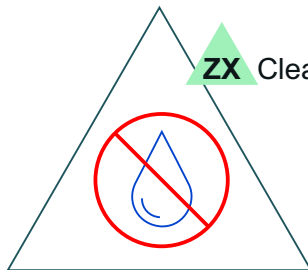
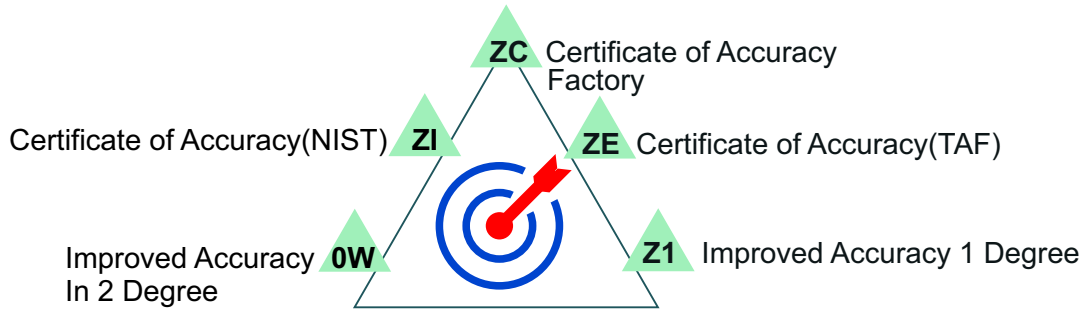

Option

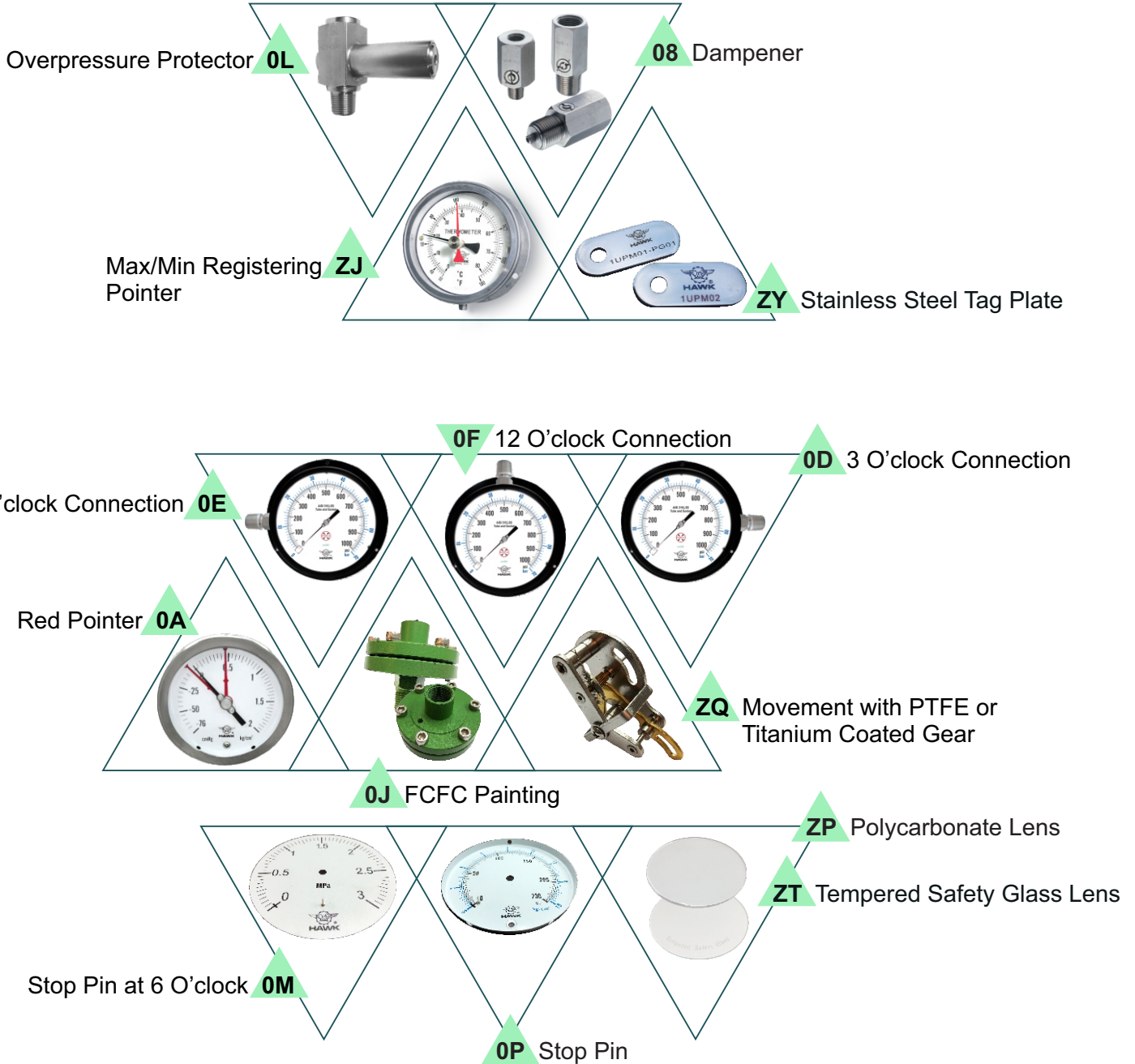

Limited Warranty and Liability

HAWK GAUGE CO.,LTD warrants all its mechanical instruments to be free from defects in materials and workmanship. HAWK agrees to repair or replace any pressure gauges if returned to our factory, transportation charges prepaid, and after which examination reveals is to be defective due to faculty workmanship or material. This warrant should not apply to subject to the following terms and conditions.

- A. The product has not been subjected to misuse, neglect, abuse , accident, incorrect mounting, improper use or misapplication such as negligence, accident, vandalism, shock or vibration.
- B. The performance of any system of which HAWK's products are a component part.
- C. The product has not been exposed to any other service, range or environment of greater severity than that for which the products were designed.
- D. The product has not been altered or repaired by anyone except HAWK GAUGE or its authorized service agencies.
- E. The serial number or date code has not been removed, defaced or changed.
- F. The actual pressure&temperature occurring exceed the values specified for HAWK Process gauge.

Unless otherwise specified in a manual or warranty card, or agree to in a writing signed by HAWK GAUGE office, HAWK Process gauge products shall be warranted for two years from the date of sale.

This warranty is in lieu of all other warranties expressed or implied, and of all obligations or liabilities on its part for damages including but not limited to consequential damages, following the use of misuse of instruments sold by it. No agent is authorized to assume for it any liability except as set forth above.

Note

HAWK GAUGE CO.,LTD reserves the right to make product improvements and change its specifications at any time stated throughout this brochure without notification. Please contact the factory on all critical dimensions and specifications for verification.

HAWK GAUGE is not expert in the customer's technical field and therefore doesn't warrant suitability of it's product for the application selected by customer.



Data Sheet No: MKDP1J10A3-E